

SLIDING SYSTEM FOR CLOSET

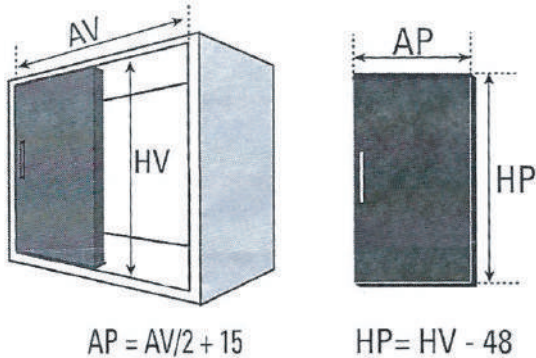

Cod. DUCLOSET DOBLE Installation guide

Unscaled format

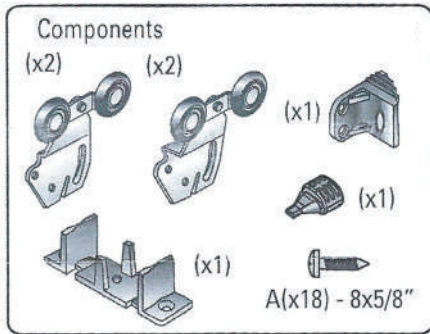
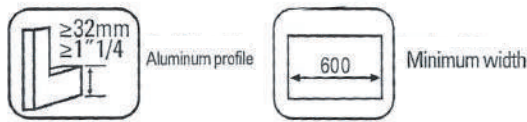
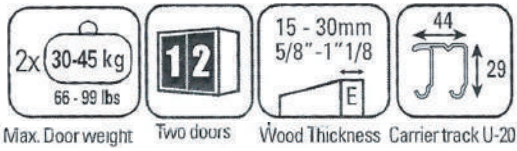

mm	Decimal inches	Aprox Fraction	mm	Decimal inches	Aprox Fraction
1	0.0394	3/64	6	0.2362	15/64
2	0.0787	5/64	7	0.2756	9/32
3	0.1181	1/8	8	0.3150	5/16
4	0.1575	5/32	9	0.3543	23/64
5	0.1969	13/64	10	0.3937	25/64

All measurements in millimeters.

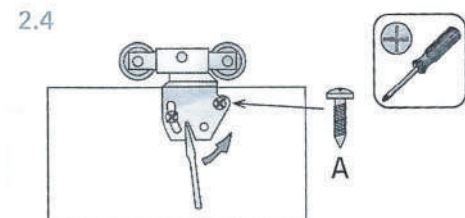
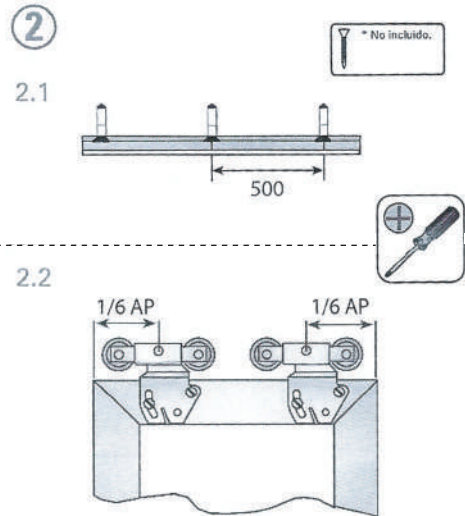
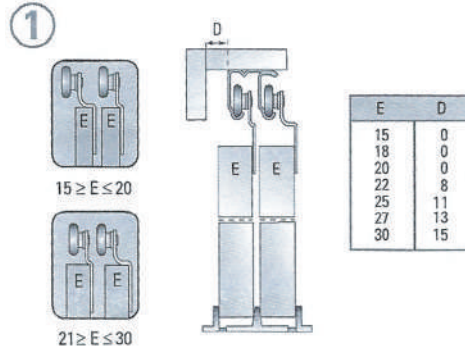

2.5

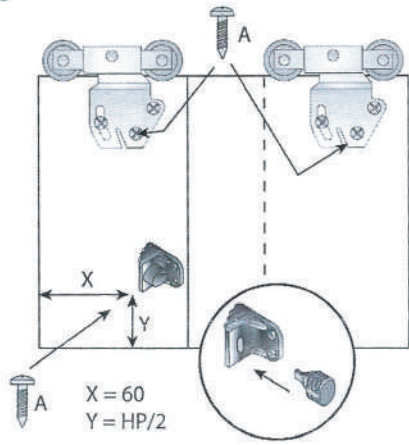

2.6

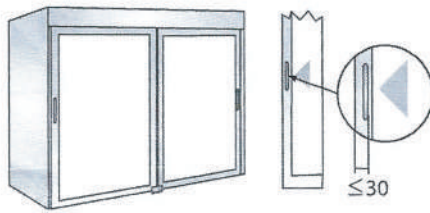

3

3.1

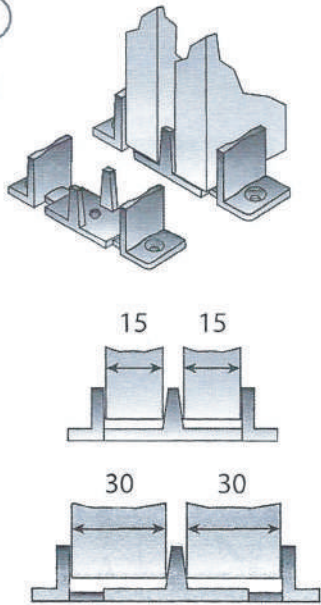

3.2

3 A

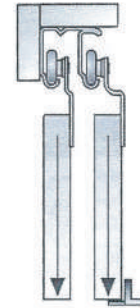
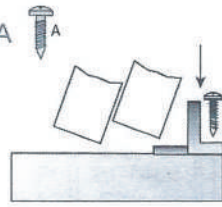

3 B

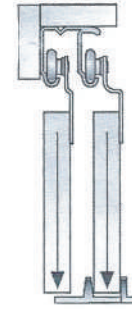
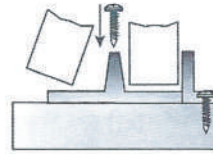

3 C

