

# JALADERAS PARA EMBUTIR



Guía de corte para mueble

WFH112X75

Formato sin escala

Corte de mueble

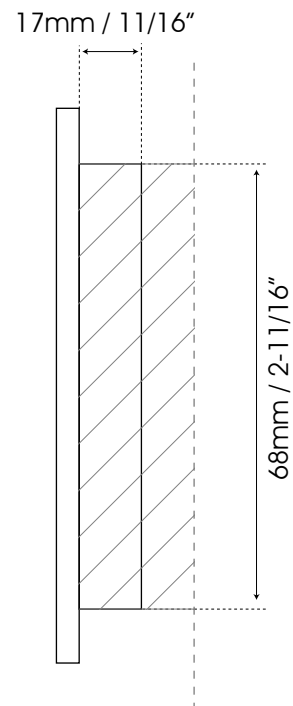
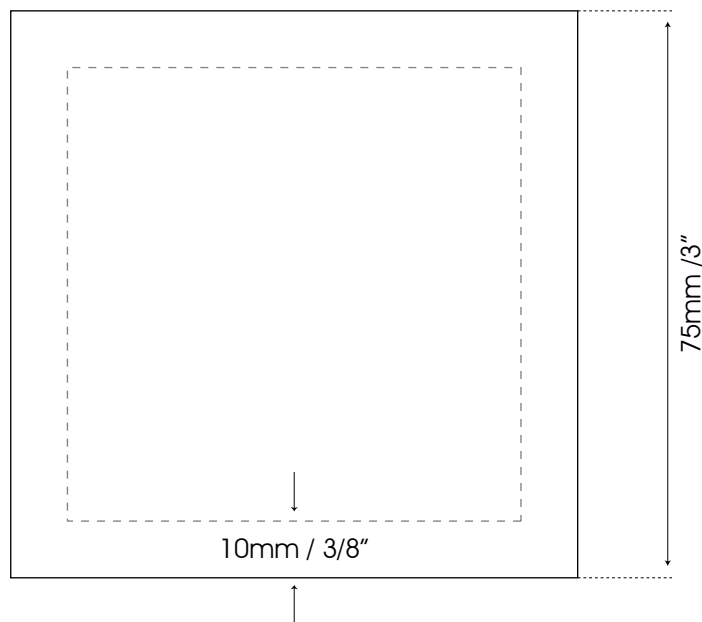
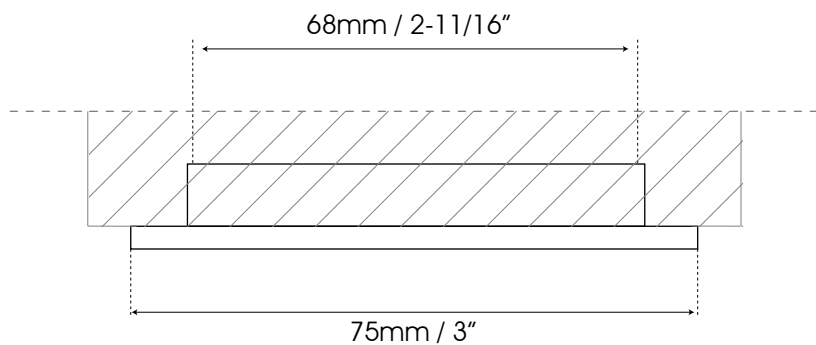

Aplicar pegamento epóxico al borde.