

# LADDER PULL HANDLES

## OFFSET LADDER PULL HANDLE BACK-TO-BACK



Cod.L4248X60SS-SET

Cutting guide

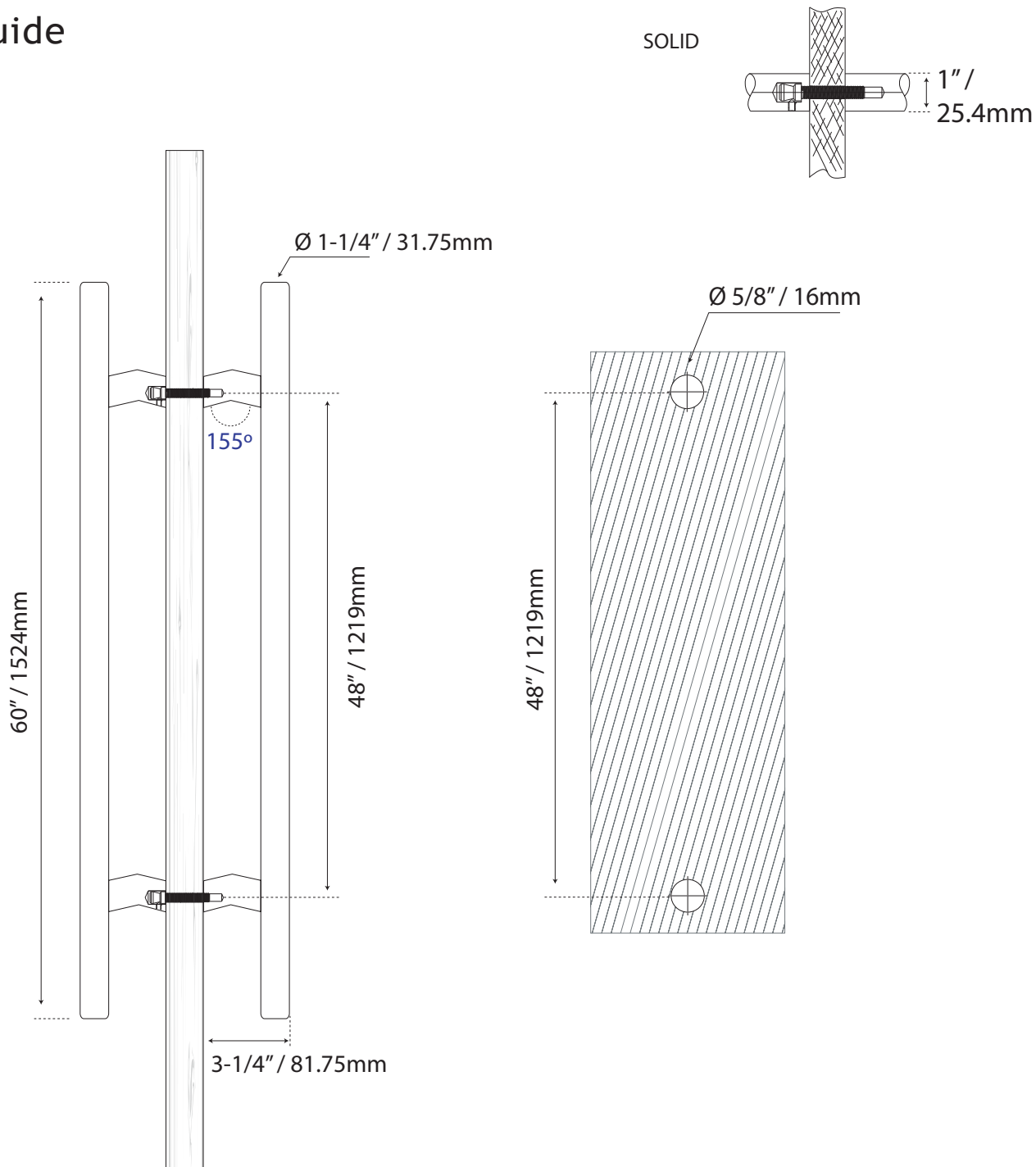

Unscaled format