

JALADERAS PARA PUERTA

MANILLÓN TIPO "H" SET



COD. L2060X72-SET

Guía de corte

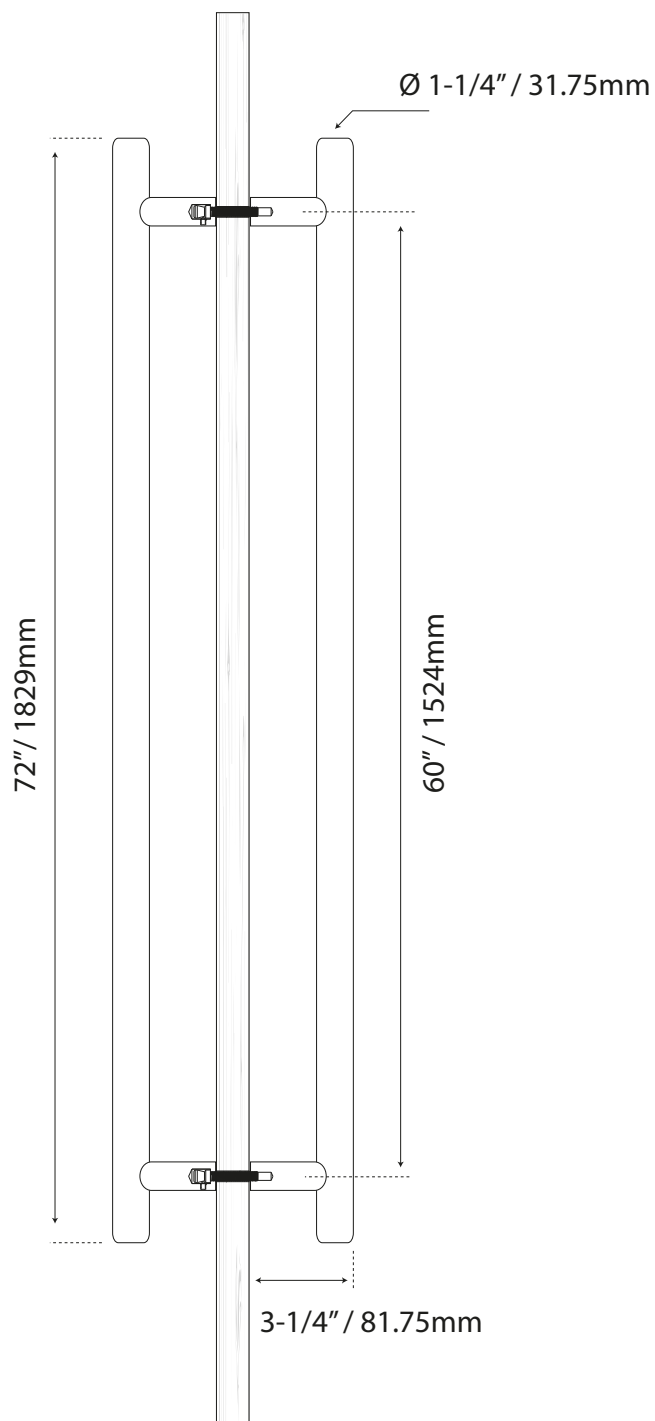

SOLID /
SÓLIDO

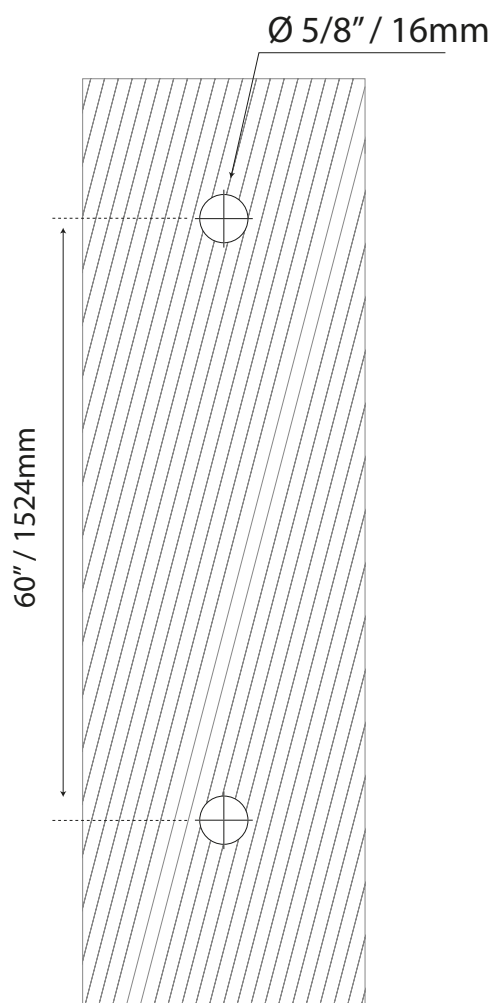
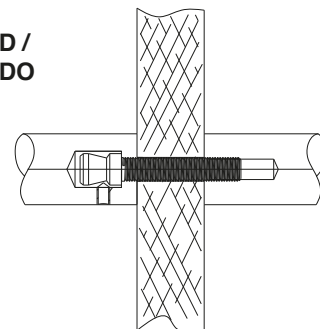

Formato sin escala