

CORREDERAS

CIERRE SUAVE 6D



Guía de Instalación

Formato sin escala

TS01

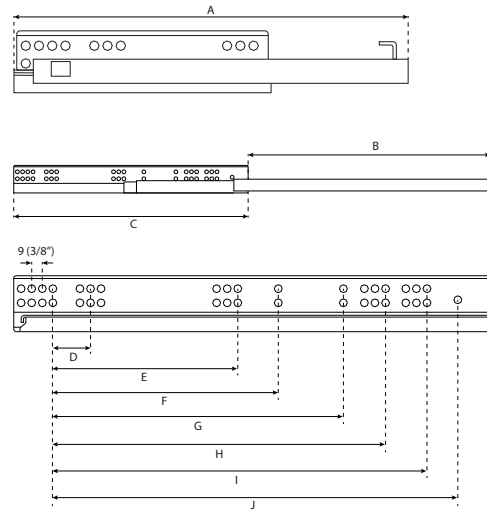

Installation Dimensions/ Dimensiones de la Instalación (mm)

NL= Nominal Slide Length LT=Internal Cabinet Depth LT=NL+3
Standard drawer

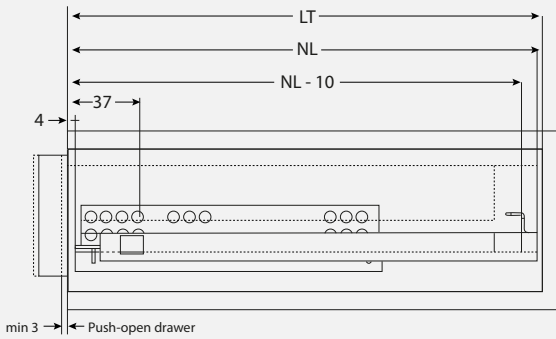

CODE/ CÓDIGO	A	B	C	D	E
TS01-300H	11-13/16" / 300mm	9-5/8" / 244mm	10-3/8" / 263mm	1-1/4" / 32mm	5-1/16" / 128mm
TS01-350H	13-3/4" / 350mm	11-5/8" / 295mm	11-1/4" / 285mm	1-1/4" / 32mm	5-1/16" / 128mm
TS01-400H	15-3/2" / 400mm	13-9/16" / 345mm	11-5/8" / 295mm	1-1/4" / 32mm	5-1/16" / 128mm
TS01-450H	17-11/16" / 450mm	15-9/16" / 396mm	11-5/8" / 295mm	1-1/4" / 32mm	5-1/16" / 128mm
TS01-500H	19-11/16" / 500mm	17-5/8" / 447mm	13" / 330mm	1-1/4" / 32mm	5-1/16" / 128mm
TS01-550H	21-5/8" / 550mm	19-1/2" / 495mm	14-7/16" / 367mm	1-1/4" / 32mm	5-1/16" / 128mm

F	G	H	I	J	
6-5/16" / 160mm	-	8-13/16" / 224mm	-	-	10
-	-	8-13/16" / 224mm	-	-	10
-	7-9/16" / 192mm	8-13/16" / 224mm	10-1/16" / 256mm	-	10
-	7-9/16" / 192mm	8-13/16" / 224mm	10-1/16" / 256mm	-	10
-	-	8-13/16" / 224mm	10-1/16" / 256mm	-	10
-	-	8-13/16" / 224mm	10-1/16" / 256mm	11-1/2" / 292mm	10

NL= Nominal Slide Length LT=Internal Cabinet Depth LT=NL+21
Inner drawer

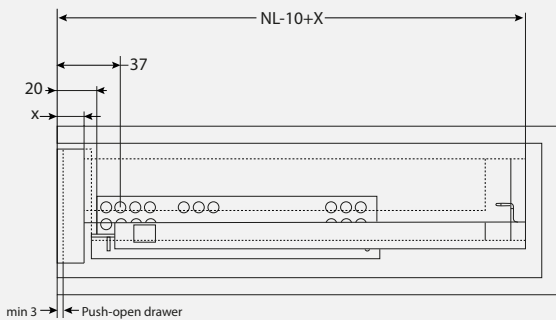

Drawer Back Preparation/ Preparación del cajón (mm)

Soft close drawer

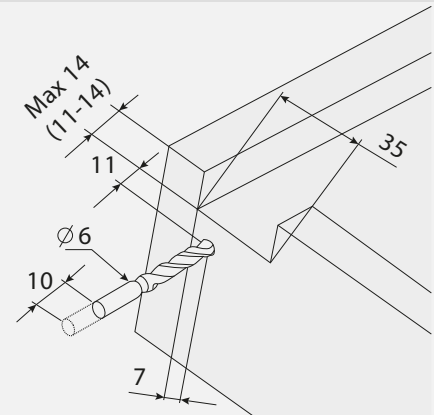

SKW=Internal Drawer Width LW=Internal Cabinet Width

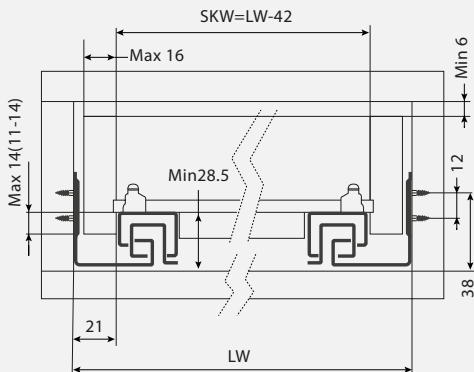

Locking Device Installation/ Instalación del clip (mm)

2D Locking Device

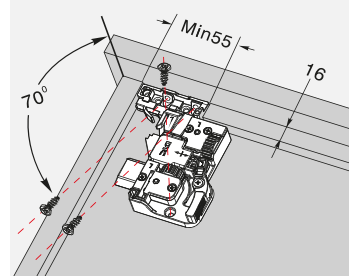

3D Locking Device

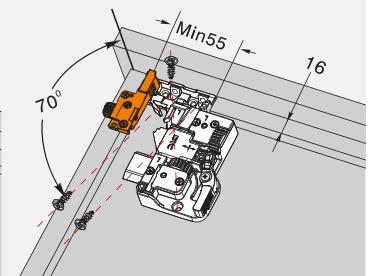

All measurements are approximate / Las medidas son aproximadas